



Juop

celebrating 40 years in business



1976

2016



Just Understanding Requests Of People

Founded in 1976, JUROP is an Italian company specialised in the production of vacuum pumps, displacement pumps and compressors for the agricultural and industrial sector. Its main strength is constructing ecology equipment, intended for extraction or transport of special and hazardous waste and for high pressure washing of industrial installations and sewers, constructed with unique customisation levels.

The company's commitment has always been aimed at achieving total quality, with regard to the entire production process: from the design stage to the construction and standardisation of products.

To ensure the reliability of its products, JUROP boasts a number of certifications issued by the competent authorities in the field, both nationally and abroad.

JUROP's widespread presence within vast markets bears significant witness to the reliability of the company and its products. The company currently has a presence in over 80 countries worldwide, as well as Italy.



1976-1980

1976

The business was launched in 1976, in an industrial building in Villotta di Chions, with the design and construction of the first decompressors, already mainly intended for foreign markets. The flow rate of the first models reached 6500 l/min (390m³/h).

A few years later, the first JUROP production facility was inaugurated in Azzano Decimo, for the production of purging solutions.



The first corporate logo design



The headquarters in Villotta di Chions



The first premises at Azzano Decimo in via San Giuseppe

1976

The decompressors of the P series, air cooled, were the first to be marketed by the company, which back then was a general partnership. The flow rate specifications, from 3000 to 6500 l/min, allow them to be specifically used in agricultural applications.

JUROP branded products featured a high degree of reliability from the very start.



Model P4N of the P series

1977

The PR7 decompressor is intended for the industrial sector. Particularly suited for application on tanker trucks for gully emptying, fixed and mobile systems for purifying and vacuum systems in general. Unlike the models of series P, it is water cooled.

Equipped with oil tank, automatic lubrication, diverter, check valve and hole for vane inspection, it has an extraction capacity of 6400 l/min.

The P7R decompressor is easy to install, with low operating and maintenance costs but above all, for the times, it is relatively noiseless during operation.



The P7R model



Application of a P7R on purging equipment

1978

The purging equipment features wide application options from the very start. Made for undercarriages, trailers and semitrailers, fixed or roll-on, they use vacuum pumps produced by JUROP.

This type of outfitting is produced for purging cesspools, road manholes, and septic tanks, for drainage in general and for extraction and transport of sludge, thick liquids and dirty water.



An example of VAC equipment

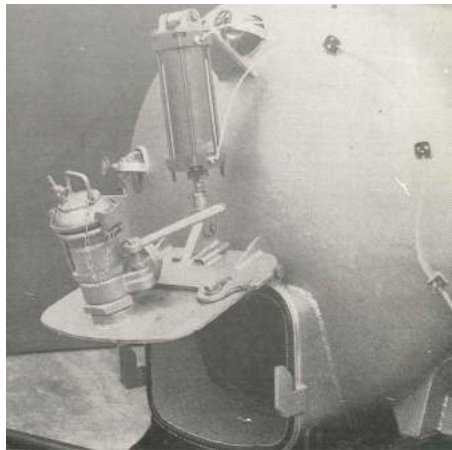

The capacity of the first tanks ranges from 2 to 25 m³

1979

The water cooled PR vacuum pumps were designed and constructed specifically to be used on equipment for cleaning cesspools and sewers. However, they may be used in other sectors as well, such as transport of bulk materials and gas pumping.

In 1979, production starts of models P900R and P1500R, with a flow rate from 16000 to 25000 l/min and maximum vacuum equal to 92%.



The P1500R model

1979

The VAC-JET outfits made on industrial undercarriages are designed to perform the most complex civil and industrial cleaning operations. They are developed to replace the conventional agricultural tankers, which back then were used also for industrial cleaning applications, although with low performance. This equipment is suitable for combined extraction of liquid waste and high pressure water cleaning, thanks to the JET function. Manifold solutions are developed for the water compartment to meet the requirements for capacity, correct weight distribution and design. Each outfitting, since the very first model, was designed and customised to meet the most specific customer requirements.



An example of VAC-JET equipment



Rear assembly drawing of a VAC-JET outfitting

1980

The vacuum pumps of the PN series, evolution of the P series, are used in the agricultural sector on tankers for collecting and spreading animal manure. With model PN10600, the achieved flow rate is 640 m³/h.

Cooling takes place with a natural air flow on the outer fins of the body. The vacuum pumps may be fitted with a 2 or 3-way mixer for mixing the liquid in the tank of the tanker while spreading on the ground.



PN8400 fitted with MIXER

In Bologna, at the EIMA trade fair (11-15 November 1980), the company introduces JULIA: the innovative extraction-centrifugal unit applicable to all Jurop pumps.

The slogan states that:

“JULIA is intended for that segment of manufacturers who demand zero servicing, who don't like contingencies, in other words, for those people who always opt for the best the market has to offer in order to be operatively safe”.



PN series (top from left: PN2300, PN3300, PN4500, PN5800, PN8400, PN10600 mixer, PN10600 and PN12500



The JULIA unit introduced at EIMA



1981-1985

132780 PM

1981

In October 1981, Jurop takes part in the 17th edition of SaMo Ter, the international Trade Fair of Earth Moving equipment for the building site and construction. But what is the underlying factor of Jurop's success? It can be read in the invitation sent to customers on the occasion of the Verona fair:

"Always be available for the customer, make them feel wholly at ease, understand their needs, offer friendship and technical-practical advice, willing to offer comprehensive support. Jurop loves its customers and this is the basis of its success".

jurop®

The new corporate logo design

The vacuum pumps of the R series are specifically designed to be used on tanker trucks for industrial and civil cleaning applications. Thanks to the patented air injection cooling system and to automatic lubrication, they were able to work non-stop for several hours. The high degree of vacuum and the capacities, from 250 to 700 m³/h, made these the best pumps one could find on the market in the eighties. This is confirmed by the long production life of this range, especially on foreign markets and specifically, on the US market.

Attraverso questo messaggio la Jurop ringrazia clienti ed amici che con la loro fiducia hanno contribuito alla crescita dell'azienda.

Una crescita ormai inarrestabile, poiché dietro ogni nostra realizzazione c'è ricerca, lavoro, sforzo creativo oltre all'impegno di portare idee nuove in un settore destinato a rapida evoluzione.

Saremo presenti alla Fiera nel padiglione 2 stand n. 54-55 ove Vi invitiamo ad un dialogo sugli aspetti pratici e allo scambio di esperienze reciproche finalizzate alla massima cooperazione.

JUROP tecnologia avanzata su misura

The invitation to the 17th SaMo Ter in Verona



The R model

1983

TORNADO, the leading equipment in the field of extraction, is launched in 1983. TORNADO is the ideal instrument to perform operations to remove, recover and transport any kind of material. Three set-ups are available. T models were designed for extraction of sewage, industrial sludge and solid materials. TP models, compared to the previous ones, were designed for extracting powders. TPC models have the same features listed above but are designed for high pressure cleaning of ducts, underground canals and industrial washing, combined with the extraction function of the materials resulting from high pressure cleaning.

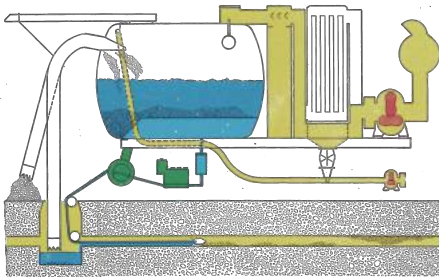

Operating diagram of model TPC

J8000 is a decompressor with two-vane rotor that was designed in the eighties for agricultural and industrial uses. The extremely rational and above all essential design assures high reliability over time and remarkable performance (maximum vacuum 95%). Air cooled, J8000 is equipped with an automatic lubrication system.



The J8000 model

In 1983 Jurop introduces MINISPIDER: the compact-sized universal excavator. Minimum overall dimensions, nimbleness, manoeuvrability and essentialness are the features that allowed this product to reach the smallest and narrowest spaces which no other excavator had reached before. Designed for people, MINISPIDER conquered automation in a field where until then, one operated manually.



MINISPIDER: the universal excavator

1985

1985 is the year of the JP series. This is a rotary lobe pump used for filling, mixing, emptying, irrigating and draining liquids.

Operation is immediately straightforward, effective and noiseless: two rotary lobes fitted on two parallel shafts contained in one case, rotate in opposite directions. The outline of the rotary lobes and case is such as to assure evenness in the flow rate of the conveyed liquids in every stage of the extraction and delivery cycle. The flow rate specifications of the JP series range from 1420 to 5100 l/min.



The JP model

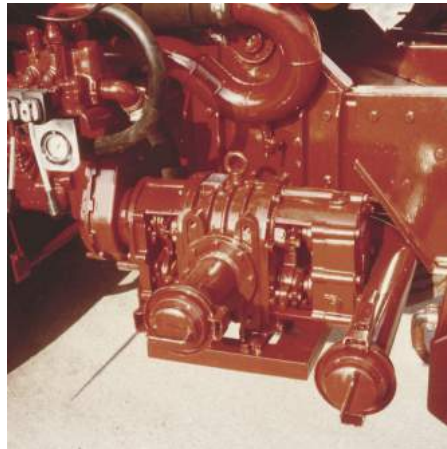

Application of a JP piston pump

The M series is designed for use in milking systems or other systems requiring a limited 30% vacuum level and a low flow rate. This did not exceed 5000 l/min for model M160, the largest in the range.



The M model



1986 - 1990

1986

Vacuum pumps P1200R and P2000R, evolution of the previous PR, are the rotary vane type, water cooled, complete with water recirculation pump and automatic lubrication pump.

In 1986, when production is launched, the air flow rates are respectively:

P1200R: 1300 m³/h – 21,660 l/min

P2000R: 1950 m³/h – 32,500 l/min

Used for extraction of liquids, sludge and slurry, they are immediately applied on medium-large equipment, on undercarriages, on wheeled equipment and fixed installations.

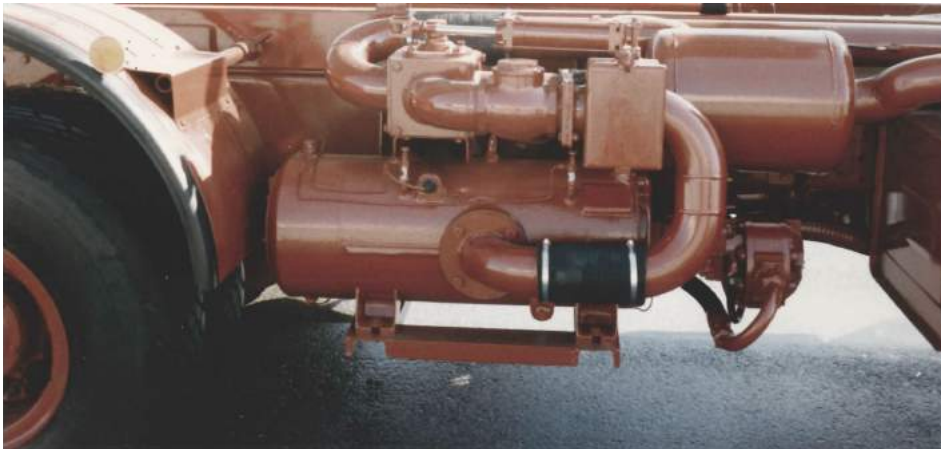

Application of a P2000R



Design of the new corporate logo



The P2000R model

1987

The BLOWER is a centrifugal, multi-stage extractor able to supply clean, dry air, non-pulsed and at virtually constant pressure, for use in process industries for pneumatic conveyance, dust extraction, centralised vacuum systems and water processing. The BLOWER is maintenance-free and reaches flow rate up to 18000 m³/h.



The Blower

1988

In 1988 Jurop starts a partnership with the Italian State Railways. The project entails production of three different types of outfitting for cleaning and emptying the storage tanks holding the sewage from train toilets.

The first is a wheeled system used in emergency cases, suited to emptying one toilet only. The second is an outfitting on a two-axle chassis with timed sequence for emptying, washing and sanitising of several toilets on the same train. The last is a fixed outfitting, installed in the train stations of Rome, Milan, Florence, Bologna and Lecce, it is used for simultaneous treatment of all toilets on a train.



The two-axle developed in partnership with FS

Model P620R is the smallest water cooled vacuum pump.

Used for extracting liquids and sludge, it features a flow rate of 620 m³/h.



Application of a P620R in a motorised unit

1989

Also in 1988, the JUNIOR unit is developed. Consisting of a vacuum pump (PN, R, or P620R) and a centrifugal pump, it is ideal for spreading the manure collected in the tank of the agricultural tanker.

The PTOs for operation of the mixing systems in the tank, and the hydraulic pumps for actuating the tanker's own services, are supplied on request



The JUNIOR model

In 1989 JUROP exhibits its products at Lingotto of Turin. These include models P1200R and P2000R, the JP piston pump and two outfits (with two and three axes) for combined extraction of liquid waste and cleaning with high pressure water.

In November of the same year, the company is in Bologna for EIMA: International Fair of Agricultural Machinery.

In 1990 it takes part in SEP POLLUTION



The stand at Lingotto

1990



jurop

Via Cassanese di Corva, 27
33030 Treviso di Adone X. (TV)
Tel. (0434)832847
Telex 430134 JUII
Telefax (0434)832332

- autocisterne spurgo
- attrezzature pulizia alta pressione
- impianti mobil/fissi aspirazione ed insediaggio polveri e granulati
- pompe per vuoto
- pompe per movimentazione liquami e prodotti viscosi

VI INVITIAMO A VISITARCI AL
SEP POLLUTION
PADOVA

DAL 1 AL 5 APRILE '90

The design of the invitation to the Padua trade fair



1991 - 1995

1991

The VL pump is developed to convey viscous, fibrous products, sludge and paste containing abrasive materials or suspended solids, up to a diameter of 30 mm.

Two lobes rotating in opposite directions capture the material in the space between them and the pump body, convey it from the extraction inlet to the outlet. The flow of the material may be inverted by changing the direction of rotation. The cast iron lobes are coated in NBR, a synthetic rubber. The pump is self-priming.

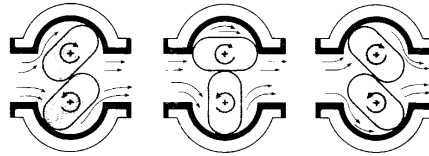

Diagram of a VL's operating principle

In the early nineties, production of the SI units starts. These are PTOs with 50 kW input power and 25 kW output on each shaft, which make it possible to drive two fixtures simultaneously or alternatively. For example, a vacuum pump and a high pressure water one.



The VL20 model



Cleaning fossil fuel deposits with VL in Dublin



The SI 4 model

Since 1991 Jurop has been constructing equipment for waste of ADR classes 3 - 4.1 - 5.1 - 6.1 - 6.2 - 8 - 9 intended for various countries. This type of equipment for collecting and transporting hazardous waste is also suited for separate collection thanks to the tank with multiple compartments constructed in stainless steel. For these outfittings it gained recognition from the relevant competent authorities, including: Italian Ministry of Transport, German TÜV, Swiss EMPA- SVDB and the Spanish Ministry of Industry.



New design of the company logo

1992

The range of vacuum vane pumps of the PR series is extended and designed with the purpose of optimising the air path, achieving high volume performance and extremely noiseless operation. Tangential vanes are introduced, able to increase pump efficiency while reducing wear of the body and vanes.

Production of model PR530 (3200 m³/h air flow) starts at the end of the eighties while, in 1992, model PR330 is introduced, whose air flow is equal to 2000 m³/h, approx. 33500 l/min.



An example of ADR



The first version of model PR330

1995

Increasingly tailor-made to meet the customer's requirements, JUROP equipment is normally fitted with total PTO and both mechanical and hydraulic motion transmission of the pumps.

The tank is now fitted with easily variable compartments, in the operating stage, both for extracted sludge/sewage and for the water used in high pressure washing. In the same outfitting, for vacuum production in the tank and for high pressure washing, several pumps are used with different specifications.

At the same time, a new material is adopted for making the tanks: CORTEN, a self-protecting steel.



An example of VJC

Roll-on/Roll-off equipment is designed and produced for customers interested in diversifying their activity without being forced to increase the number of vehicles.

In the nineties Jurop is able to offer Roll-on/Roll-off systems that can operate either with the vehicle's hydraulic system or independently with auxiliary engine.



An example of Roll-ON / Roll-OFF



1996 - 2000

1996

1996 marks the start of production of the new lobe displacement pumps: models VL2 and VL4, the flow rate of which ranges from 230 to 460 l/min.

To make inspection and replacement of the lobes faster and easier, access to the pumping chamber is at the front without involving seals and transmissions (see picture).



The model VL2

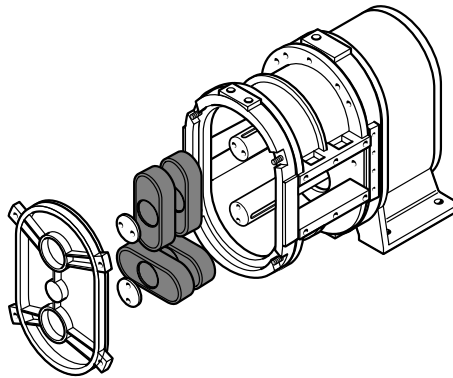

VL front lobe access

1997

The following year, models VL35 and VL50 are launched on the market, the maximum flow rate of which is respectively 3500 and 5100 l/min. These are coated lobe displacement pumps, suited to pumping liquids containing solid foreign matter with maximum size 30 mm and self-priming up to a depth of 5 metres.

The range, later to be added with model VL17 (1700 l/min), is immediately available in the version with standard seals or with reinforced seals. The latter assure greater tightness at higher operating pressures.



The model VL50

1998

VJ TRONIC is the first and most innovative electronic system for controlling equipment. The on-board computer, one of its kind, through automatic and independent speed adjustment of the pumps and motor, wholly controls the equipment. The result is to simplify the operator's work and to optimise usage of the system, achieving previously unthinkable levels of efficiency and energy saving.

VJTRONIC is a patented system.



Outfitting with a VJ TRONIC system of optimised work control

The PNR/PNE vacuum pumps/compressors use construction principles that until then were exclusively applied in industrial pumps. These are rotary, sliding vane vacuum pumps cooled with air injection (PNR models) or natural convection (PNE models). The PNR version is suitable for heavy-duty applications.

The controlled inlet of ambient air allows the pump to be cooled even in heavy-duty applications. The system was patented.

The diagram on the following page illustrates the operating principle.



The model PNR with multiplier

1999



Injection cooling: operating diagram



The model PNR with direct transmission



Suction unit with pneumatic 4-way valve

2000

At the threshold of the new millennium, the experience accrued in various sectors (agriculture, industrial, civil and transport) means the company's production is technically advanced and with high operational effectiveness. The presence of Jurop on the national and foreign market has provided it with such expertise as to allow it to develop a series of extremely flexible and targeted products, able to cater for the most specific needs and the most diverse demands.

The very materials used for JUROP's outfittings are specifically selected to assure the equipment is operational in Kazan as well as in Abū Dhābī.



An example of tailor made outfitting



2001 - 2005

2001

The new millennium starts with the production of a new series of products: the DL vacuum pumps-compressors.

The entire range may be used as filtered air decompressors or compressors in fixed and mobile installations for vacuum production, for pneumatic conveyance or extraction of liquid waste and dust.

The DL pump is a lobe, displacement pump and is cooled by air injection. Operating with no contact between rotors and body, wear is virtually non-existent and the pump does not require lubrication hence, most importantly, polluting emissions are wholly absent.



The DL140 model

The RECYCLING SYSTEM enables a percentage of suctioned water to be reused thanks to the separation of a large part of the solid particles in suspension, which might otherwise damage the high-pressure pump or pipes. Therefore, a continuous amount of clean water is guaranteed without needing to resort to external supplies. Moreover, the system enables the thickening of sewage and the consequent transport of larger amounts of solid materials containing minimum percentages of water. This results in: extreme operative efficiency, absence of downtime in the sewage emptying and water filling stage, time and fuel savings. Four types are available: with 2 compartments, 3 compartments, 3 compartments with flocculant system and 2 compartments with cyclone battery.



Example of a recycling unit

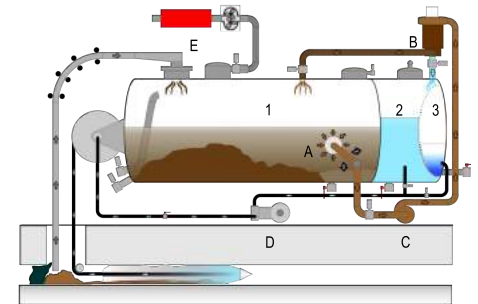

LEGEND

- 1 - sludge compartment
- 2 - recycled water
- 3 - fresh water

- A - primary filter
- B - cyclone
- C - recycling pump

- D - high vacuum pump
- E - vacuum pump

Diagram of a recycling system with 2 compartments

2002

PVT vacuum pumps are 3 lobe blowers specifically designed for vacuum plants that must convey gas free from polluting substances, oil or water: this is made possible due to the lack of sliding parts, and therefore oil lubrication within the compression chambers.

Moreover, PVT blowers do not need any auxiliary cooling system, as they are provided with a built in air injection cooling system.



Model PVT400 with the first air-injection system



The new extension in via Crosera

2003

In 2003, production starts of a new rotary, radial vane, air cooled rotary vacuum pump: model PN140.

The flow rate achieved is 13850 l/min (830 m³/h). The series is to be complemented with models PN130 (12900 l/min), PN155 and PN155 R (15200 l/min).



Model PN140

2004

AZ shredders are designed to meet the demand for a product to be used in organic waste processing, intended for biomass energy production and in all applications requiring to shred the pumped material. Set up for operation with pressure up to 5 bar, they may be paired to electric motors with power up to 55 kW.

Equipped with rotating knives driven by two synchronized shafts, JUROP grinder is designed to shred and grind biologics, solids and gross particles deriving from livestock waters etc. in order to obtain a homogenous mixture to be recycled on biogas plants.

Most suitable the coupling with rotary lobe transfer pumps, VL series.



Power units with the AZ shredders

In 2004, the displacement compressors of the CT series are launched, suitable to conveying gas free from pollutants such as suspended oil or water. The CT series may be intended for use in potentially explosive atmosphere consisting of flammable gas, vapours, mists and dust.

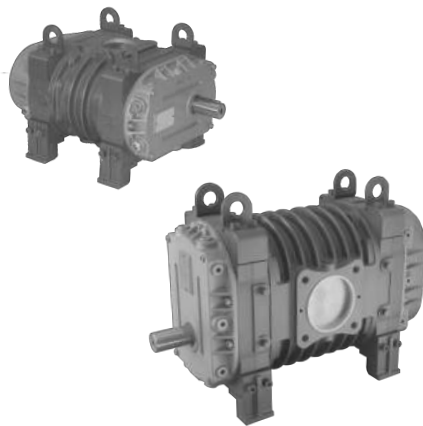

Models CT80 and CT130

2005

LC420 is a radial vane rotary vacuum pump with liquid cooled body, which allows it to operate even in the most heavy-duty applications with high volume yield and low noise level. The range is completed with models LC300 and LC580, with air flows up to 18000 l/min.



Power unit with the LC420 pump



2006 - 2010

2006

Every product, before being launched on the market, undergoes strict operative, functional and regulatory testing. This work requires time and must be performed with accuracy, but is required to clear any reservations on the validity of the results and to ensure the equipment complies with the regulations of the country it is intended for.

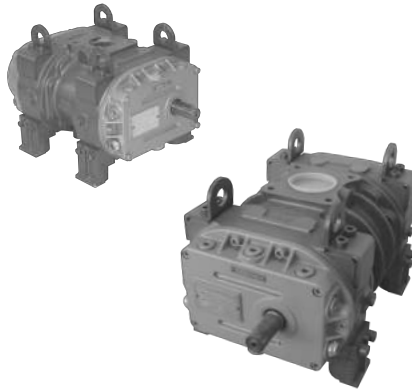

CT series: models CT30 and CT50



Example of a recycling unit

2008

To integrate assembly and use of the displacement pumps, the VJ valve is designed and produced.

VJ is a universal pressure relief valve suited to processing water and soiling or fibrous fluids such as sludge and mixes, containing abrasives or solid parts in suspension. Available in the VJ30 and VJ60 versions, it features adjustable opening pressure from 2 to 7 bar based on the spring anchoring point. The processed flow rate ranges from 1400 to 3000 l/min for VJ30 and from 3000 to 6000 l/min for the larger model.



Model VJ60

2009

In 2009, an innovative system is designed and constructed for cooling decompressors of the PVT series. This system consists of a side air injection manifold, in light alloy, with built-in swing check valve.

This new system allows the noise pollution arising from use of the decompressor to be reduced, with significant savings in terms of encumbrances and costs resulting from the soundproofing systems required otherwise.

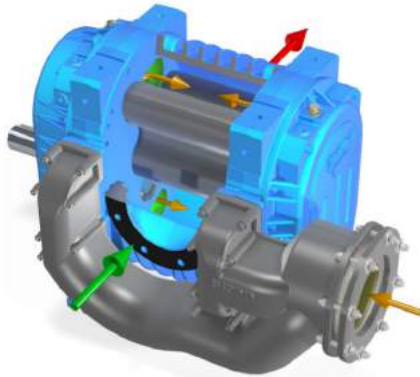

The new PVT pump side injection system



The innovative side injection system in an outfitting

2010

Between 2009 and 2010, production of certain models starts, to extend and complete the range of existing products: these include the PN155 and LC300 vacuum pumps.

However, the RV series, consisting of models RV360 and RV520, is newly designed. These are rotary vacuum pumps with forced air cooling by means of two juxtaposed, high efficiency impellers. Use of the impellers makes it possible to significantly increase the continuity and service life of the pump.



The first version of model RV360

2010 is also the year of PNR142 SL. This is a sliding vane, rotary vacuum pump cooled by air injection. The pump assures a 70% vacuum in continuous operation and air flow of 14200 l/min. The side position of the oil tank (SL), with capacity equal to 4 litres, makes it possible to prevent overheating the oil.



The first version of model PNR142



The current version of the company logo



The building site of the pumps/decompressors facility in the Fiumesino industrial estate



2011 - 2015

2011

In 2011 JUROP celebrates 35 years in business.

Trust must be deserved and requires to be continuously confirmed.

JUROP has gained it over time thanks to the use of state-of-the-art design and construction technology, use of high quality materials, and production of increasingly customised products, featuring sophisticated yet easily managed systems.



JUROP 4x4 outfitting



ADR outfitting for dust extraction

2012

In 2012 the CT240 decompressor is launched which, together with models CT420 and CT600, complements the range of CT decompressors assuring up to 6400 m³/h air flow.

In the same year, production starts of the LC580 vacuum pump, with liquid cooled body. It is presented in combination with the JULIA7000 centrifugal unit at the EIMA fair in Bologna in the same year.

The JULIA series is completed, between 2013 and the following year, with models JULIA8000, JULIA8500 and JULIA9000. All models are fitted with two outlets: a vane or lobe vacuum pump is applied to one of them, a centrifugal pump to the other.



JULIA7000 with LC580

2013

In 2013, ASL740-260 is launched: the liquid extractor used in industrial settings, able to extract in just 2 minutes 500 litres of liquids such as lubricating coolants, water and oil.

ASL740-260 is also effective to extract solid residues such as slurry, sediment, sludge and metal shavings (150kg in 5 minutes).

The solid residue is separated from the liquid one, which is then recycled.

The care for detail, in recent years, has become one of the company's strengths. JUROP has been able to combine technical expertise and design flair, increasing the efficiency of its equipment, introducing innovative systems to make them easier to use, reducing weight and overall dimensions by using increasingly lighter materials and, last but not least, with an eye to the overall design.



Model ASL740-260



Equipment for extraction and conveyance of liquids and sewage from purging septic tanks

2014

For extraction and cleaning in environments with explosion hazard, Jurop makes equipment fitted with a high performance vacuum pump, filter and flame breaker elements, a high pressure water pump as well as a drainage pump, to handle thick sewage independently from the tank. The first ATEX outfitting dates back to 2010.



ATEX logo

Starting from 2014, the entire DL series undergoes restyling. The decompressor with three-lobe rotors in synchronised rotation uses an innovative cooling system with built-in check valve.

The dynamic shape of the injection system makes it possible to redistribute the extracted air in a consistent manner, through four access points, reducing overheating of the decompressor during heavy-duty applications. The ball check valve is replaced by a swing check valve built into the new manifold.

The system is patented.



Example of an ATEX outfitting



Model DL250

2015

Developed as variants of the RV series, models RVC210 and RVC360 are rotary vacuum pumps cooled with forced air with one or two opposite impellers. The innovative side manifold fitted with built-in swing check valve and a wide range of specific accessories, assure compact dimensions and support new installation solutions.



Model RVC210 with its accessories

2014 ends with the presentation of the PVT280 pump, the latest in the range of decompressors with three-lobe rotors and side injection cooling system.

The entire series of PVT decompressors is presented at the IFAT fair in Munich, the largest trade fair worldwide in the sector of water, sewers, waste and raw materials management.



Series PVT Atex at IFAT 2014

In 2015 SYNC is patented, a set of accessories for guiding and supporting piping, in equipment used for collecting and/or processing waste. The control unit supplied is programmed to achieve synchronous rotation of the two accessories (e.g. side-mounted reel and spout).

The synchronisation ensures faster and more precise positioning of the two accessories, resulting in shorter operating time, regardless of the operator's skills.

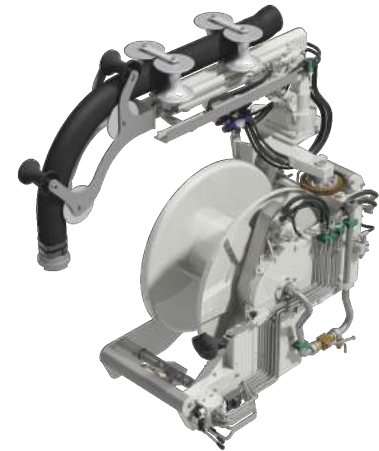

SYNC applied to a side-mounted reel and a suction boom

C series compressors are of the radial vane, rotary type and are air cooled.

C60, C84 and C110 are suited to convey high pressure air up to 5 bar (6 bar abs) in the pipes of agricultural machinery used for irrigation (self-propelled), to empty them from water so they may be moved more easily in the open field.

The coated lobe pump is a self-priming displacement pump, without valves, in which flow rate varies proportionally to the rotation speed.

The new VL70 and VL140 models stand out from the other displacement pumps as they have a separation chamber between the gear box and the pumping chamber. Another innovative aspect of the new VL is the helix-shaped lobes, which ensure liquids and sewage are conveyed without any irritating flow pulses.

VL70 and 140 were presented in preview in Hannover, at the Agritechnica fair.

Those who contact JUROP know they can rely on a global consultancy service, in close partnership with the clientele and continuous through time.

Even after placing a product on the market, the company undertakes to assure its assistance, providing its own staff or making use of local engineers.

The service offered is not only limited to solving any technical issues, but also to studying effective solutions addressing the onset of new and unforeseen needs.



Compressor C84



Model VL70



Example of a VJC outfitting with two PVT1000 (140000 l/min)



2016 - ...

2016

About one hundred outfits were produced in 2016. The last ones are being constructed and are to be delivered at the start of the new year. Among these, half are intended for the foreign market: the presence in a wide national and international market is the company's best badge of honour. 2677 outfits have been constructed to date. New job orders are already in the pipeline, awaiting construction.

2016 saw the restyling of some historic JUROP-branded products. These include the new DL270 and DL300 models and the PNR series. The new PNR104 and PNR124 models and the version with side tank PNR142 boast a newly designed manifold with built-in swing check valve. However, the true novelty is the HELIX series, displacement vacuum pump with helix-shaped, three-lobe rotors and side injection cooling system. The special helical shape of the lobes assures smoother motion, without any vibrations at all. The system is patented. With the new models, JUROP assures production of decompressors with flow rate up to 106600 l/min.

The knack for improving, innovating and always looking ahead, in full environmental-friendliness, has led the company to investing in state-of-the-art technologies and machinery. 2016 is the year of large extensions.

The pumps and decompressors facility now features a modern and functional warehouse, able to store over 5 thousand item codes, and all the systems to reduce emissions and increase energy savings.

The headquarters now has a connecting gallery between the two existing buildings, and a bright meeting room is also set up with video-conference facilities for communicating with customers.



Some outfits pending delivery



The HELIX 750 model with tri-lobe rotors





JUROP is everything you have read about here, or perhaps had first-hand experience with as employees, customers, suppliers or associates. And the goal of the company's 40 years in business has been achieved thanks to cooperation with each one of you.

This anniversary is the opportunity to acknowledge what has been done and what can still be done in the future, with you and for you.

Heartfelt thanks to all of you.





EQUIPMENT FACILITY (HEADQUARTERS)

via Crosera, 50 - 33082 Azzano Decimo (PN) Italia

TEL +39 0434 636811

FAX +39 0434 636812

info@jurop.it

